

DATA SHEET

Vibro-Meter®

LS120 and ILS730 air-gap measurement system



LS120



ILS730



KEY FEATURES AND BENEFITS

- From the Vibro-Meter® product line
- Contactless measurement for alternators
- Electric field principle
- No wear-out
- 5 to 30 mm linear measurement range
- Operating temperature ranges:
–15 to +125°C for the LS120 air-gap sensor
–25 to +70°C for the ILS730 signal conditioner
- Enhanced filtering of noise and spikes induced by high excitation currents
- Available with cable lengths of 5 or 10 m

APPLICATIONS

- Contactless measurement of air gap in hydroelectric generators, and other large alternators and motors

DESCRIPTION

The air-gap measurement system consists of a LS120 air-gap sensor with an integral cable and an ILS730 signal conditioner. The two devices are connected via the integral cable of the sensor, which is a pair of coaxial cables.

The LS120 air-gap sensor contains two mutually insulated electrodes (transmitter and receiver) which are shielded on the rear side. The ILS730 signal conditioner contains the electronic circuitry that excites the sensor and processes the measurement signals returned.

An oscillator in the signal conditioner feeds a high-frequency signal to the transmitter electrode of the sensor and produces an electric field. Part of this field is picked up by the receiver electrode of the sensor and is sent to the receiver circuitry.

When the sensor is mounted on the stator of a machine, the distance between the sensor and the rotor surface (the target) affects the coupling of the electric field between the transmitter and receiver electrodes. In this way, the modulated signal at the receiver output is proportional to the distance between the stator and the rotor of the alternator.



Information contained in this document may be subject to export control regulations of the European Union, USA or other countries. Each recipient of this document is responsible for ensuring that transfer or use of any information contained in this document complies with all relevant export control regulations. ECN N/A.

DESCRIPTION (continued)

The air-gap measurement system provides three output signals: POLE PROFILE, ROTOR PROFILE and MIN GAP.

- The POLE PROFILE output indicates the instantaneous value between the surface of the sensor and the rotor.
- The ROTOR PROFILE output indicates the minimum value of the air gap for each pole.
- The MIN GAP output reflects the minimum air gap value for all poles of the rotor.

Each of these measurements is available as a voltage-based (0 to 10 V) output. In addition, one of these measurements can be selected to be

also available as a current-based (4 to 20 mA) output. The selection is made by factory-set solder points which are placed according to the option chosen when ordering (see **Mechanical drawings and ordering information starting on page 6**).

All output signals are available on a screw-terminal strip on the ILS730 signal conditioner.

A range of multi-wire shielded transmission cables are available to connect a LS120 and ILS730 air-gap measurement system to monitoring and/or protection systems such as VM600 and VibroSmart®.

For specific applications, contact your nearest Meggitt representative.

BLOCK DIAGRAM

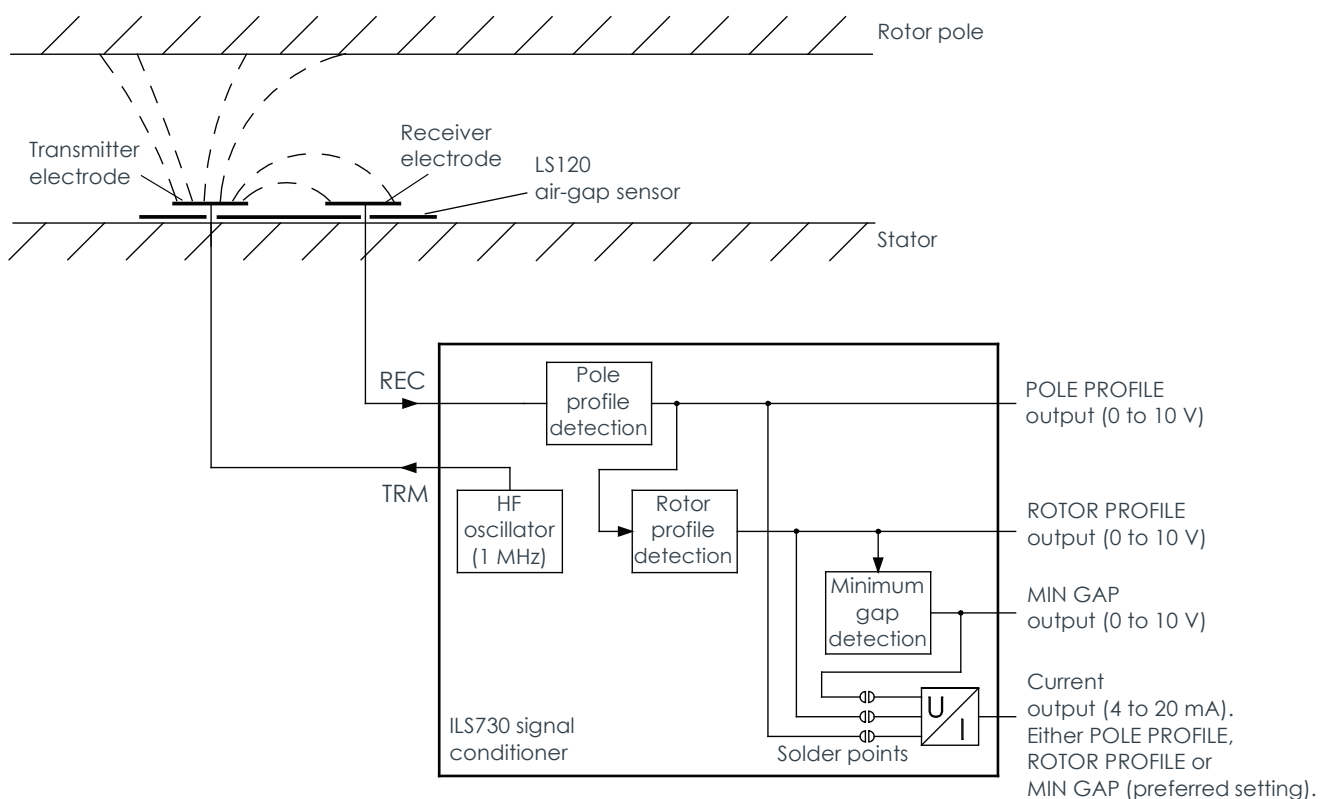

SPECIFICATIONS

Operating

Measurement range	: 5 to 30 mm. Note: 1.875 to 33.125 mm can be used (see Transfer characteristic below).
Output sensitivity	: 320 mV/mm or 512 μ A/mm
Sensitivity error (precision)	: $\leq \pm 5\%$ typical after offset compensation at 5 mm (test bench measurement)
Linearity error	: $\leq 1.5\%$ (5 to 30 mm measurement range)
Temperature drift	
• On zero (mean gap 5 V_{DC})	: ≤ 200 ppm/K
• On sensitivity	: ≤ 200 ppm/K

Transfer characteristic

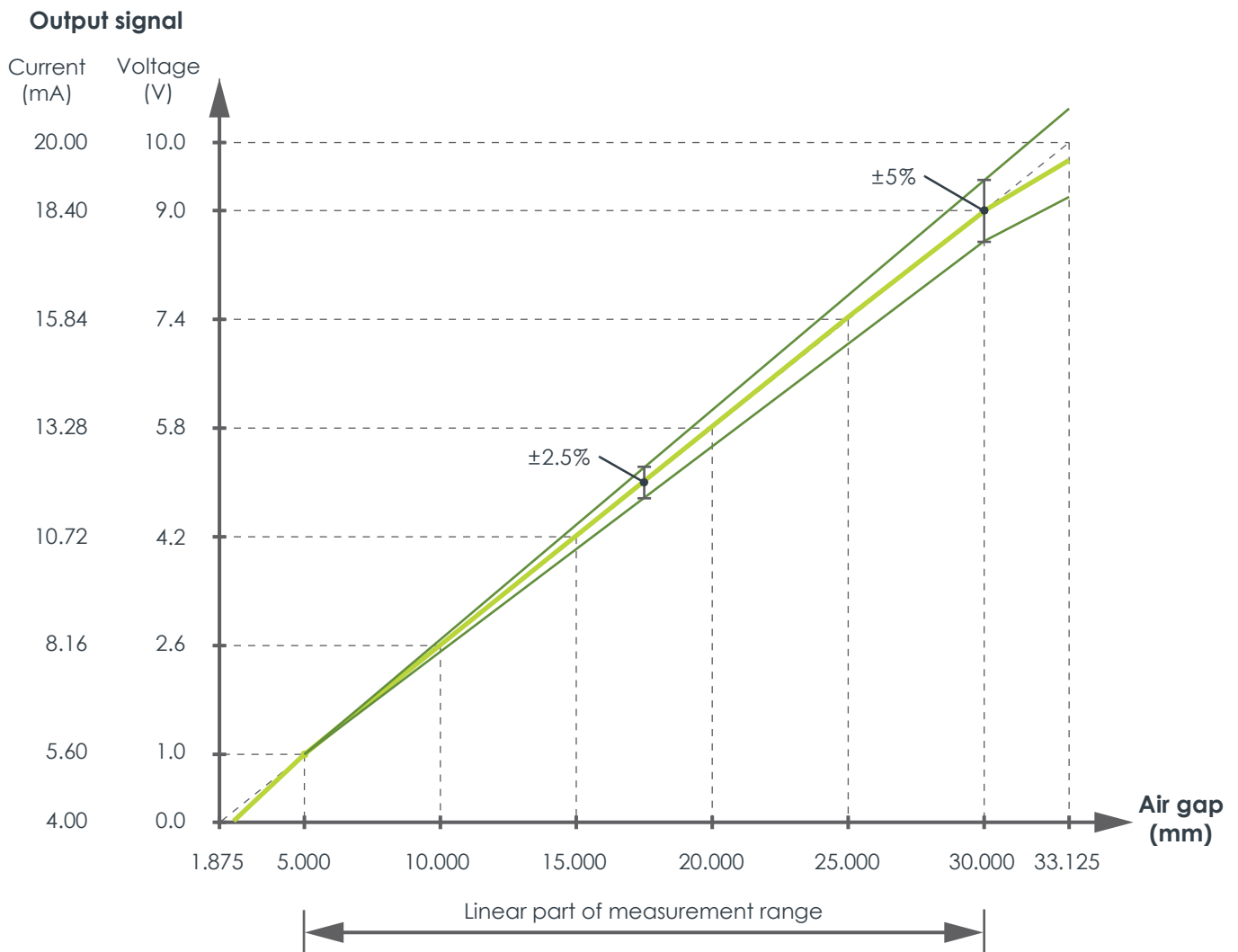

Note: This transfer characteristic curve shows the typical transfer characteristics for an LS120/ILS730 after offset compensation at 5 mm, as measured on a test bench.

SPECIFICATIONS *(continued)*

Output characteristics

Voltage outputs (0 to 10 V)

- Impedance : <20 Ω
- Minimum load resistance : 1 k Ω

Current output (4 to 20 mA)

- Maximum load resistance : 500 Ω

POLE PROFILE output

- Frequency range : DC to 1 kHz

ROTOR PROFILE output

- Trigger level : 10 V \pm 0.5 V
- Hysteresis : 0.5 V

MIN GAP output

- Peak rectifier rise time : 1 ms
- Peak rectifier decay time : 50 s

Power supply (to ILS730)

Voltage : 24 V_{DC} nom. (18 to 32 V_{DC} input range)

Current : 150 mA nom. (600 mA start-up current, 60 ms at 24 V_{DC})

Environmental

Temperature range

- Operating : -15 to +125°C (5 to +257°F) for LS120.
-25 to +70°C (-13 to +158°F) for ILS730.
- Short-term : -40 to +150°C (-40 to +302°F) for LS120.
-40 to +80°C (-40 to +176°F) for ILS730.

Humidity

: 95% max. non condensing

Protection rating

: IP40 (LS730 signal conditioner)

(according to IEC 60529)

Vibration

: 0.7 mm peak-peak, 5 g peak, 10 to 150 Hz

(according to IEC 60068-2-6)

Shock acceleration

: 15 g peak, 11 ms half-sine wave

(according to IEC 60068-2-27)

EMC

: LS120 sensor withstands 1.5 Tesla in a 50 or 60 Hz magnetic field

(according to EN 50081-2 and EN 50082-2)

Fluid compatibility

: LS120 sensor contact with liquids strongly influences measurements.
LS120 sensor contact with solvents and acids should be avoided.

Approvals

Conformity

: CE marking, European Union (EU) declaration of conformity

Electromagnetic compatibility

: EN 61000-6-2:2005.
EN 61000-6-4:2007 + A1:2011.

Electrical safety

: EN 61010-1:2010

SPECIFICATIONS *(continued)*

Physical characteristics

LS120 air-gap sensor

- *Material* : Vetronit FR4 type fibreglass
- *Integral cable* : Pair of coaxial cables (blue) protected by a common shield and FEP insulation (black)
- *Mounting* : See the adhesives in **Accessories starting on page 8** and refer to the *LS12x and ILS73x air-gap measurement systems installation manual*

ILS730 signal conditioner

- *Material* : Injection-moulded aluminium enclosure with IP40 protection rating. Note: The ILS730 is suitable for indoor use only unless it is installed in an industrial housing or enclosure that ensures a higher level of environmental protection.
 - *Electrical connections* : Screw terminals – wire section 2.5 mm² (max.)
 - *Mounting* : Without DIN-rail mounting adaptor (ordering option code I0): Four M4 screws, or equivalent.
With DIN-rail mounting adaptor (ordering option code I1): TH 35 DIN rail (according to EN 50022 / IEC 60715). For example, TH 35-15 or TH 35-7.5. See **Accessories starting on page 8**.
- Dimensions : See **Mechanical drawings and ordering information starting on page 6**

MECHANICAL DRAWINGS AND ORDERING INFORMATION

LS120 air-gap sensor

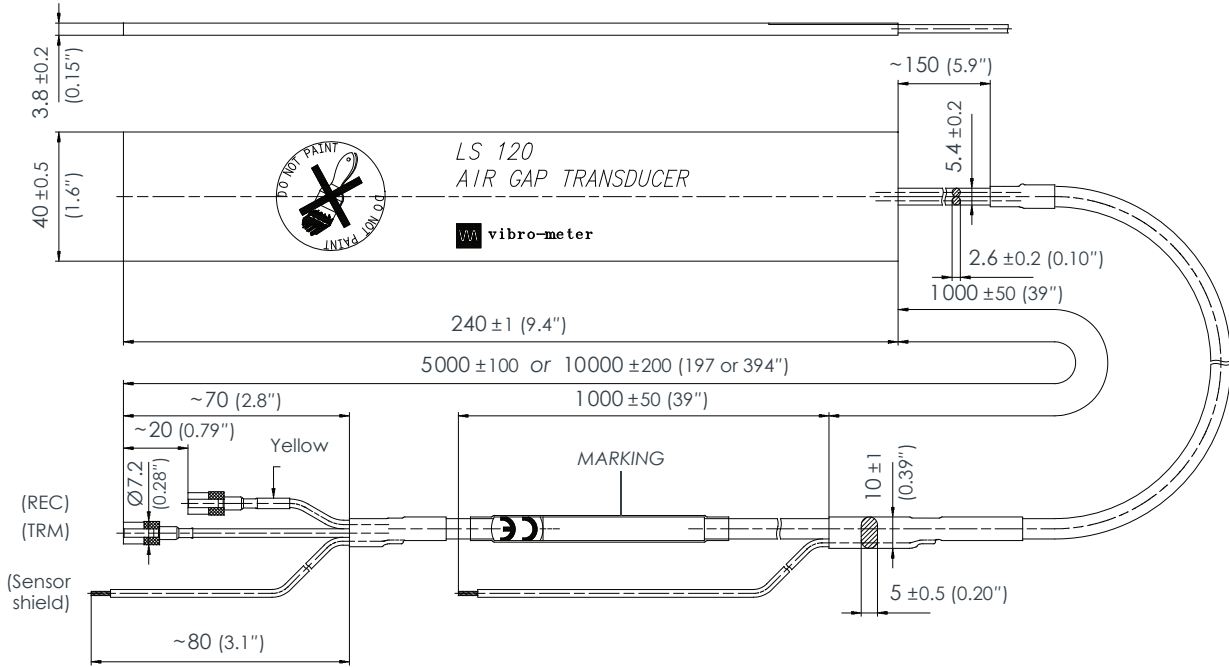

Note: All dimensions are in mm (in) unless otherwise stated.

To order please specify

Type	Designation	Ordering number (PNR)
LS120	Air-gap sensor with 5 m integral cable	151-120-000-023
LS120	Air-gap sensor with 10 m integral cable	151-120-000-123

MECHANICAL DRAWINGS AND ORDERING INFORMATION (continued)

ILS730 signal conditioner (ordering option code I0)

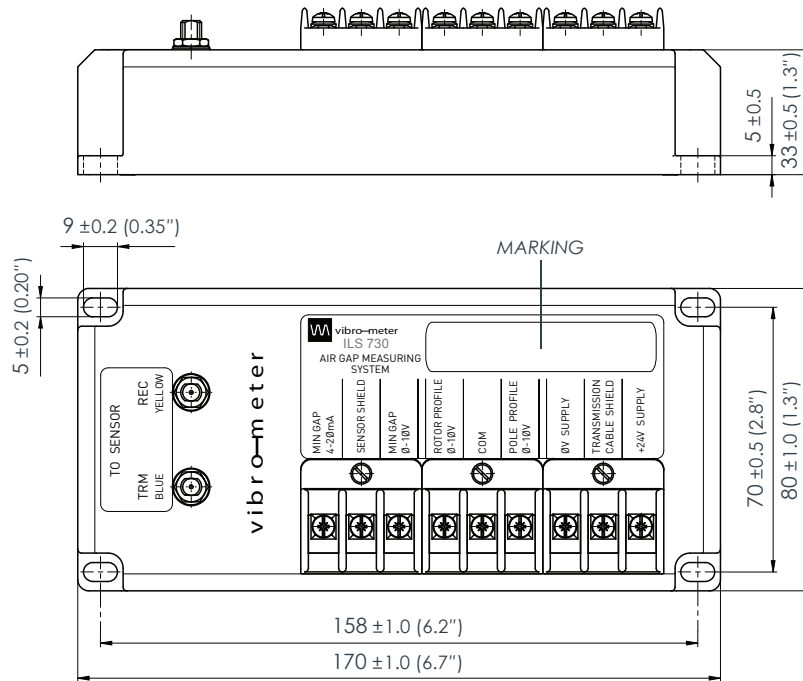

Notes:
All dimensions are in mm (in) unless otherwise stated.
This drawing shows a label for an ILS730 signal conditioner with the current output configured for MIN GAP.

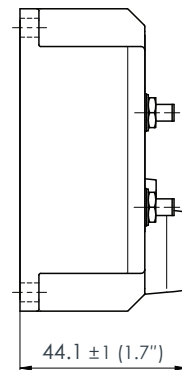

ILS730 signal conditioner with MA130 mounting adaptor (ordering option code I1)

Notes:
All dimensions are in mm (in) unless otherwise stated.
This drawing shows a label for an ILS730 signal conditioner with the current output configured for MIN GAP.

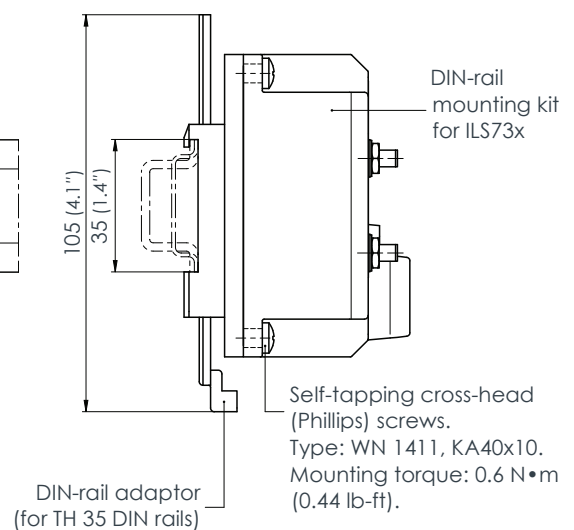
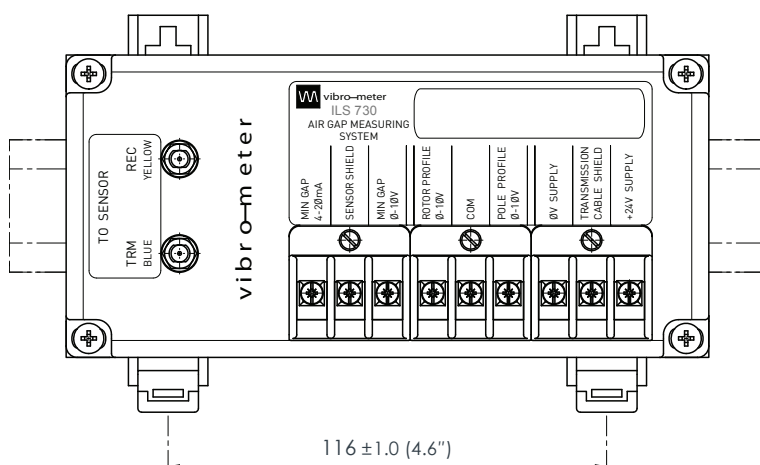

MECHANICAL DRAWINGS AND ORDERING INFORMATION *(continued)*

To order please specify

Ordering number (PNR): 204-730-000-201 /



4-20 mA output (B)	
MIN GAP	1
ROTOR PROFILE	2
POLE PROFILE	3

Total system length (H)	
5 m	05
10 m	10

Installation (I)	
Signal conditioner only	0
Signal conditioner assembled on MA130 mounting adaptor	1

ACCESSORIES

To order please specify

Type	Designation	Ordering number (PNR)
EPO-TEK T7110	Adhesive for LS12x sensors – 2 components, epoxy, contents 400 g, for mounting up to 16 x LS120. Operation up to 125°C (257°F).	Contact your local distributor
LOCTITE 330 and 7386	Adhesive for LS12x sensors – 2 components, methacrylate, contents 80 g, for mounting up to 3 x LS120. Operation up to 80°C (176°F).	965.06.01.0330
ABA17x	Industrial housings	Refer to the data sheet

Note: Refer to the *LS12x and ILS73x air-gap measurement systems installation manual* for information on the EPO-TEK and LOCTITE® adhesives.

ACCESSORIES (continued)

MA130 mounting adaptor for ILS73x signal conditioners

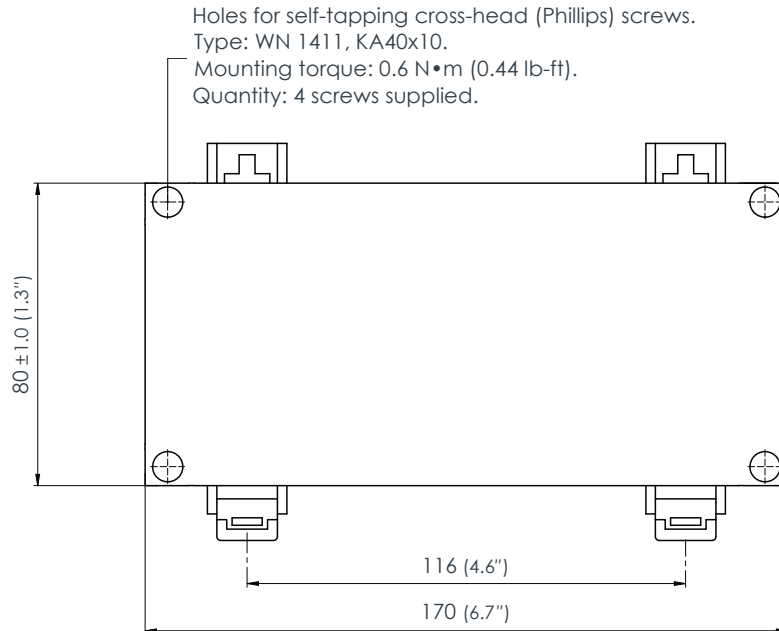

Notes:
All dimensions are in mm (in) unless otherwise stated.

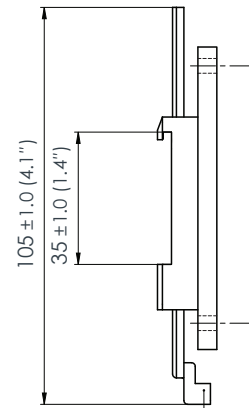

DIN-rail adaptor (for TH 35 DIN rails).
Compatibility: TH 35-15 and TH 35-7.5.

Ordering number (PNR): 809-130-000-111

Meggitt (Meggitt PLC) is a leading international engineering company, headquartered in England, that designs and delivers high-performance components and subsystems for aerospace, defence and selected energy markets. Meggitt comprises four customer-aligned divisions: Airframe Systems, Engine Systems, Energy & Equipment and Services & Support.

The Energy & Equipment division includes the Energy Sensing and Controls product group that specialises in sensing and monitoring solutions for a broad range of energy infrastructure, and control valves for industrial gas turbines, primarily for the Power Generation, Oil & Gas and Services markets. Energy & Equipment is headquartered in Switzerland (Meggitt SA) and incorporates the Vibro-Meter® product line, which has over 65 years of sensor and systems expertise and is trusted by original equipment manufacturers (OEMs) globally.



All information in this document, such as descriptions, specifications, drawings, recommendations and other statements, is believed to be reliable and is stated in good faith as being approximately correct, but is not binding on Meggitt (Meggitt SA) unless expressly agreed in writing. Before acquiring and/or using this product, you must evaluate it and determine if it is suitable for your intended application. You should also check our website at www.meggittsensing.com/energy for any updates to data sheets, certificates, product drawings, user manuals, service bulletins and/or other instructions affecting the product.

Unless otherwise expressly agreed in writing with Meggitt SA, you assume all risks and liability associated with use of the product. Any recommendations and advice given without charge, whilst given in good faith, are not binding on Meggitt SA. Meggitt (Meggitt SA) takes no responsibility for any statements related to the product which are not contained in a current Meggitt SA publication, nor for any statements contained in extracts, summaries, translations or any other documents not authored and produced by Meggitt SA.

The certifications and warranties applicable to the products supplied by Meggitt SA are valid only for new products purchased directly from Meggitt SA or from an authorised distributor of Meggitt SA.

In this publication, a dot (.) is used as the decimal separator and thousands are separated by thin spaces. Example: 12345.67890.

Copyright© 2019 Meggitt SA. All rights reserved. The information contained in this document is subject to change without prior notice.

Sales offices

Meggitt has offices in more than 30 countries. For a complete list, please visit our website.

Local representative

Head office

Meggitt SA
Rte de Moncor 4
PO Box 1616
CH-1701 Fribourg
Switzerland

Tel: +41 26 407 11 11
Fax: +41 26 407 13 01

energy@ch.meggitt.com

www.meggittsensing.com/energy

www.meggitt.com

